

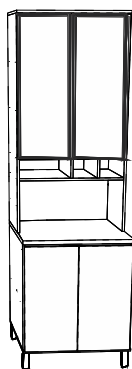

mxmóveis

Rodovia SC-492 - Km 10 - B. Industrial
89905-000 - Bandeirante - SC
Fone: (49) 3622-4549
e-mail: mxmoveis@mxmoveis.com.br



Ref. PTO01

Paneleiro
Cozinha/Cocina
TOSCANA

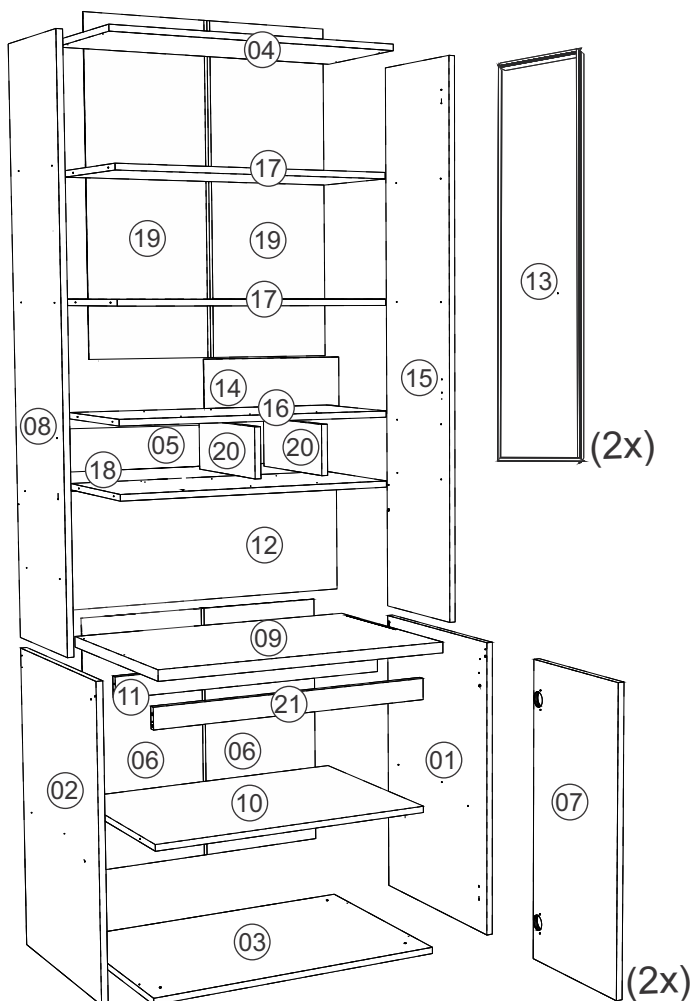

Nº	CÓDIGO ASSISTÊNCIA	NOME DA PEÇA/DESCRIPCIÓN PIEZAS	MEDIDAS (mm)	QTD.	CÓDIGO DAS PEÇAS/ CÓDIGO PIEZAS			
					FREIJÓ/FREIJÓ	FREIJÓ/NERO	FREIJÓ/JADE	FREIJÓ/OFF WHITE
01	PTO01.17.00	Lateral externa direita/Lateral derecha	710x496x15	01	209162	209162	209162	209162
02	PTO01.18.00	Lateral externa esquerda/Lateral izquierda	710x496x15	01	209163	209163	209163	209163
03	PTO01.01.00	Base inferior/Base inferior	700x516x15	01	209161	209161	209161	209161
04	PTO01.05.00	Base superior/Base superior	700x290x15	01	209175	209175	209175	209175
05	PTO01.40.00	Painel	690x135x6	01	209171	209171	209171	209171
06	PTO01.13.00	Forro/Revés	687x342x2.5	02	209167	209167	209167	209167
07	PTO01.25.00	Porta/Puerta	702x339x15	02	209154	209250	209246	222253
08	PTO01.18.01	Lateral externa esquerda/Lateral izquierda	1365x270x15	01	209170	209170	209170	209170
09	PTO01.33.00	Tampo	700x516x22	01	209168	209168	209168	209168
10	PTO01.02.02	Base interna	670x496x15	01	210471	210471	210471	210471
11	PTO01.28.01	Ripa sustentação	670x50x15	01	209166	209166	209166	209166
12	PTO01.13.03	Forro/Revés	690x360x2.5	01	209178	209178	209178	209178
13	5267	Porta/Puerta	874x339x20	02				
14	PTO01.13.01	Forro/Revés	684x164x2.5	01	209176	209176	209176	209176
15	PTO01.17.01	Lateral externa direita/Lateral derecha	1365x270x15	01	209169	209169	209169	209169
16	PTO01.02.00	Base interna	670x270x15	01	209173	209173	209173	209173
17	PTO01.02.01	Base interna	670x270x15	02	209174	209174	209174	209174
18	PTO01.02.04	Base Interna	670x270x15	01	209179	209179	209179	209179
19	PTO01.13.02	Forro/Revés	889x342x2.5	02	209177	209177	209177	209177
20	PTO01.19.00	Lateral interna menor	270x120x15	02	209172	209172	209172	209172
21	PTO01.28.00	Ripa sustentação	670x50x15	01	209165	209165	209165	209165

Ferragens/Herrajes

A  **12x**
Cavilha Ø6,0x30mm Cód. 873

B  **36x**
Parafuso 3,5x40mm Cht. Cód. 691

C  **08x**
Parafuso 4,0x14mm Cht. Cód. 667

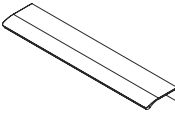
D  **04x**
Puxador / Manija Cód. 5137

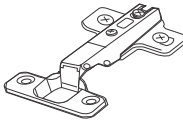
E  **08x**
Dobradiça Cód. 5491

F  **05x**
Pé plástico Cód. 5883

G  **05x**
Parafuso 5,0x50mm Cht. Cód. 1979

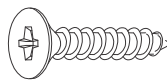
H  **08x**
Parafuso 3,5x25mm Cht. Cód. 692

I  **01x**
Perfil 889mm Cód. 9820

J  **32x**
Parafuso 4,0x12mm Cht. Cód. 7604

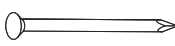
K  **136x**
Prego 8x8 Cód. 822

L  **01x**
Perfil 687mm Cód. 9819

M  **01x**
Bisnaga cola Cód. 8255

N  **06x**
Cantoneira metálica Cód. 7168

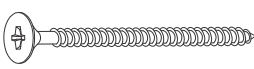

O  **18x**
Parafuso 3,0x12mm Cht. Cód. 11413



P  **04x**
Parafuso 4,0x50mm Cht. Cód. 12537

Q  **08x**
Fixador costa Cód. 7169

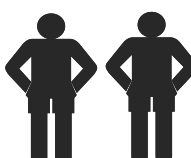

Medidas em mm

 *Usar os parafusos (G) para unir este módulo a outro. Usar los tornillos (G) para unirse este módulo a otro. 

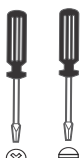
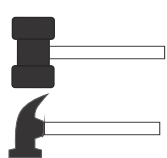
		 1:00		
---	---	---	---	---

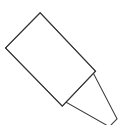
 Giz para madeira	<i>Produto para ser aplicado em caso de riscos na superfície</i>
---	--

Pré-Montagem/Preparación Piezas

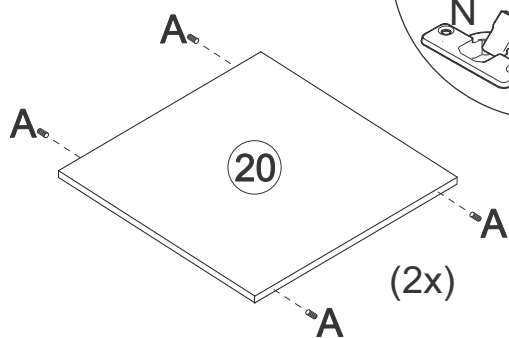
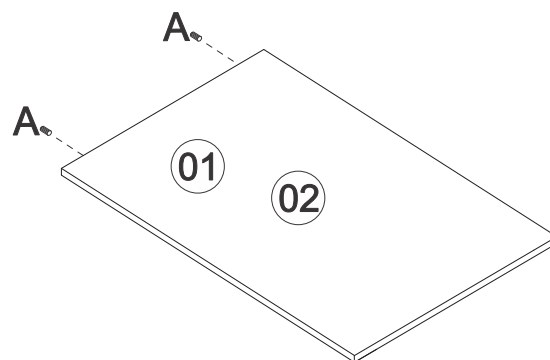
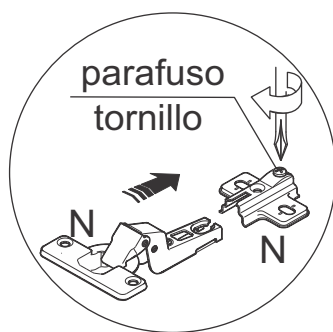
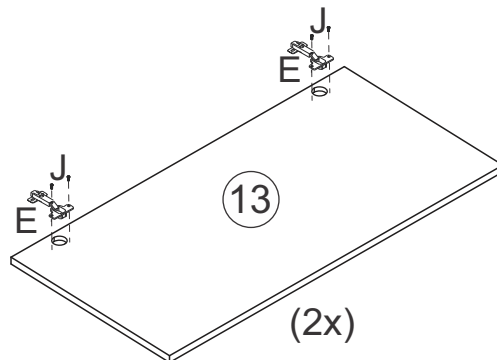
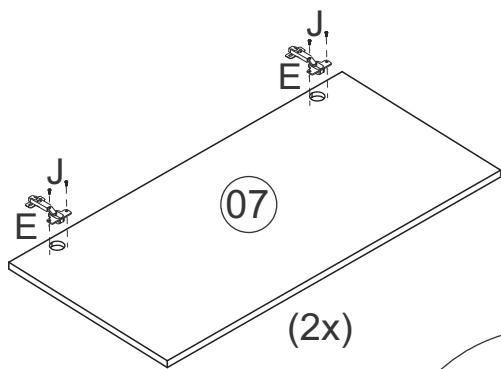

Utilizar cola nas cavilhas.

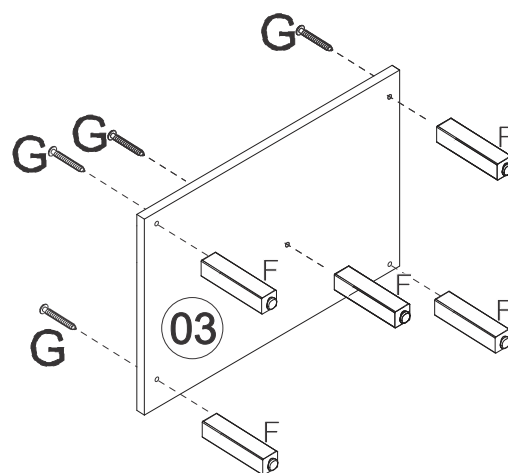

01 → Montagem/Montaje

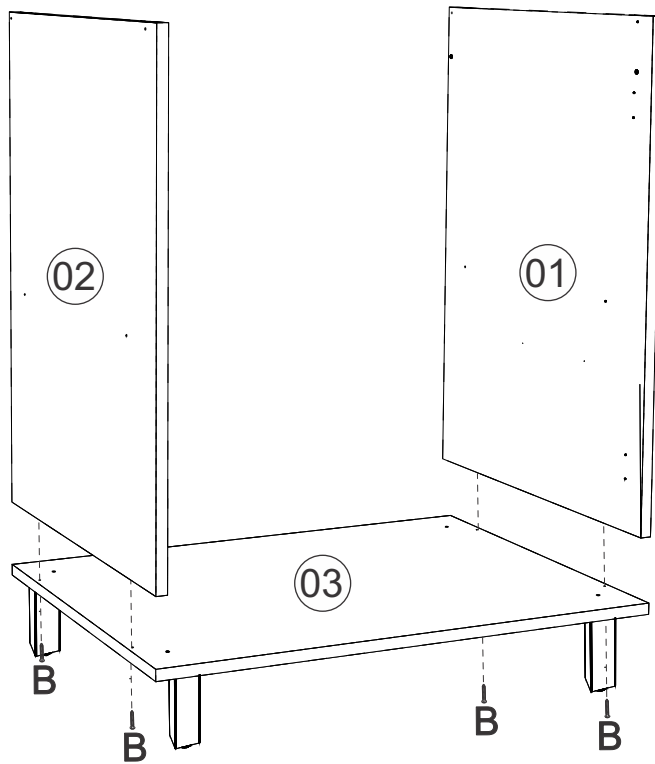

02 → Montagem/Montaje

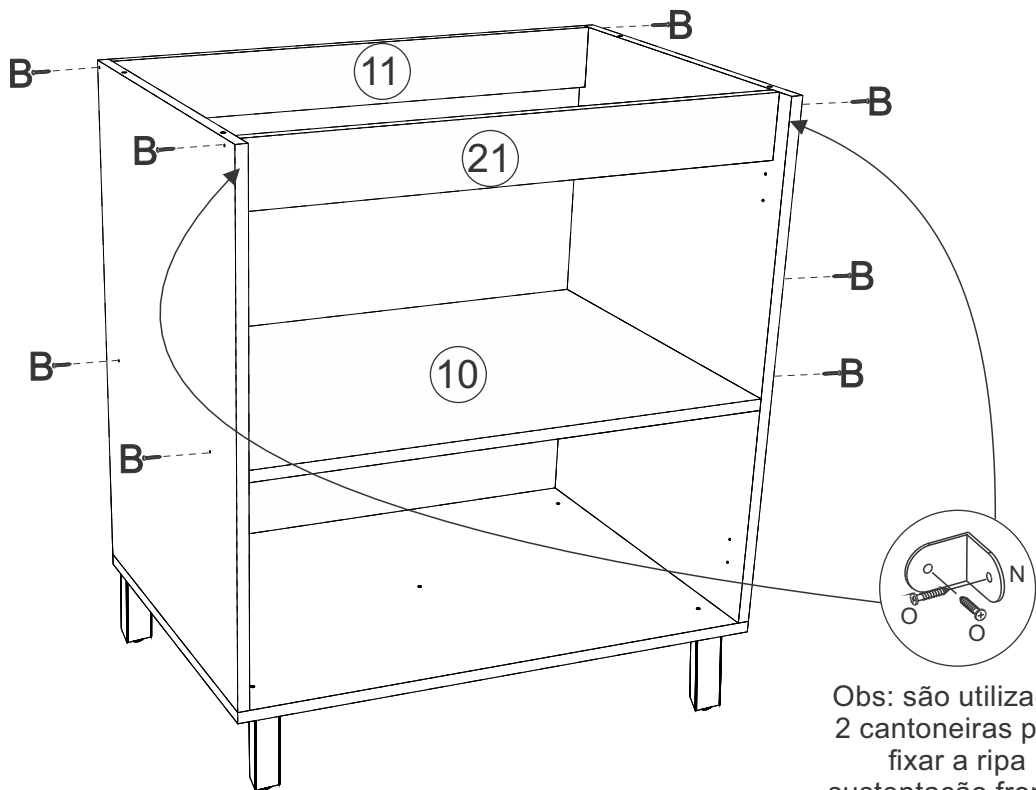

Obs: são utilizadas
2 cantoneiras para
fixar a ripa
sustentação frontal.

03 Montagem/Montaje

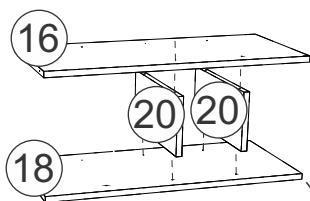

Tomada USB deve ser encaixada no painel

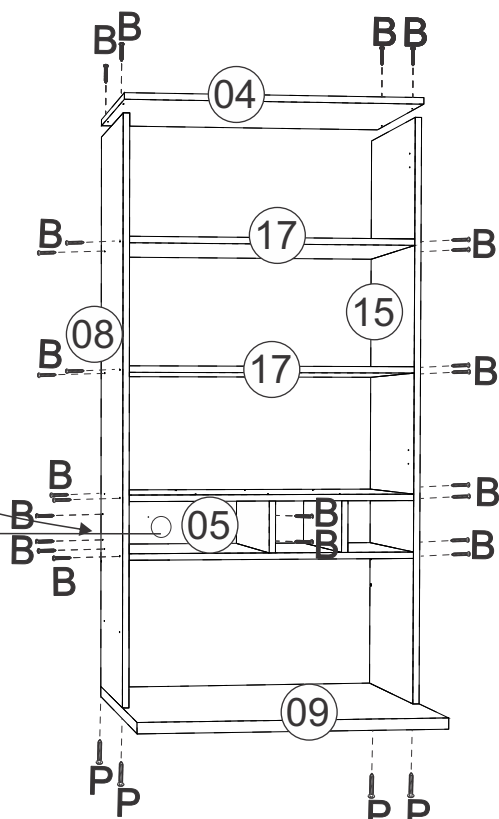

Obs: São utilizados 4 parafusos 4,0x50 para melhor fixação do paineleiro

04 Montagem/Montaje

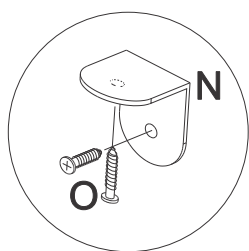

Obs: são utilizados 4 cantoneira para fixação do tampo.

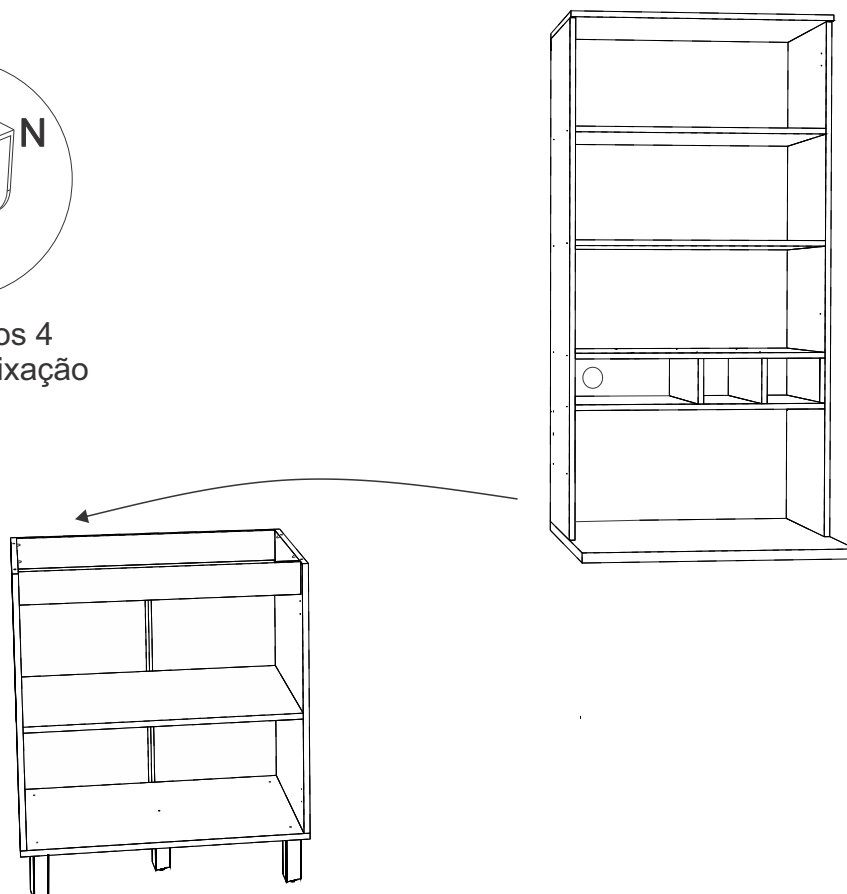

05 Montagem/Montaje

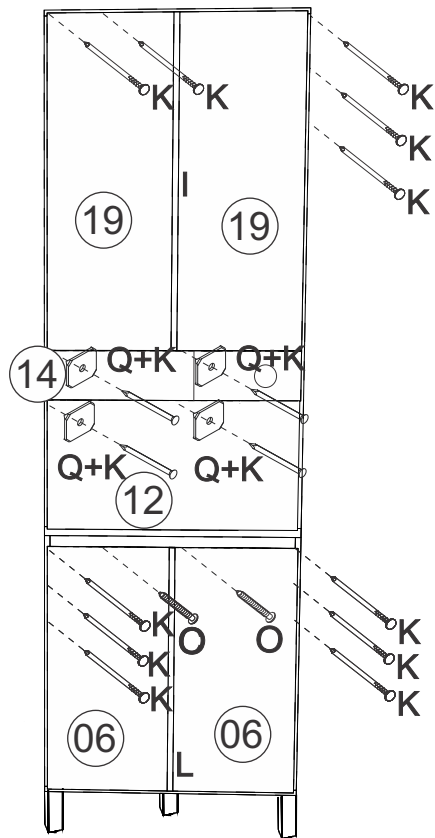

06 Montagem/Montaje

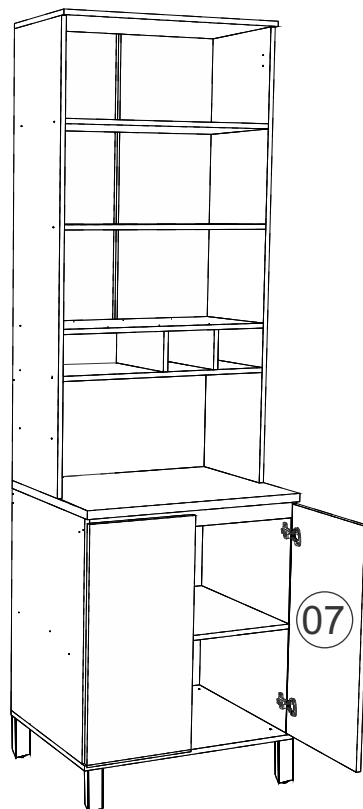

07  Montagem/Montaje

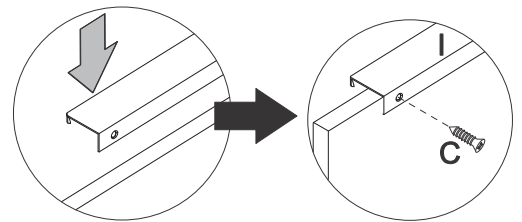
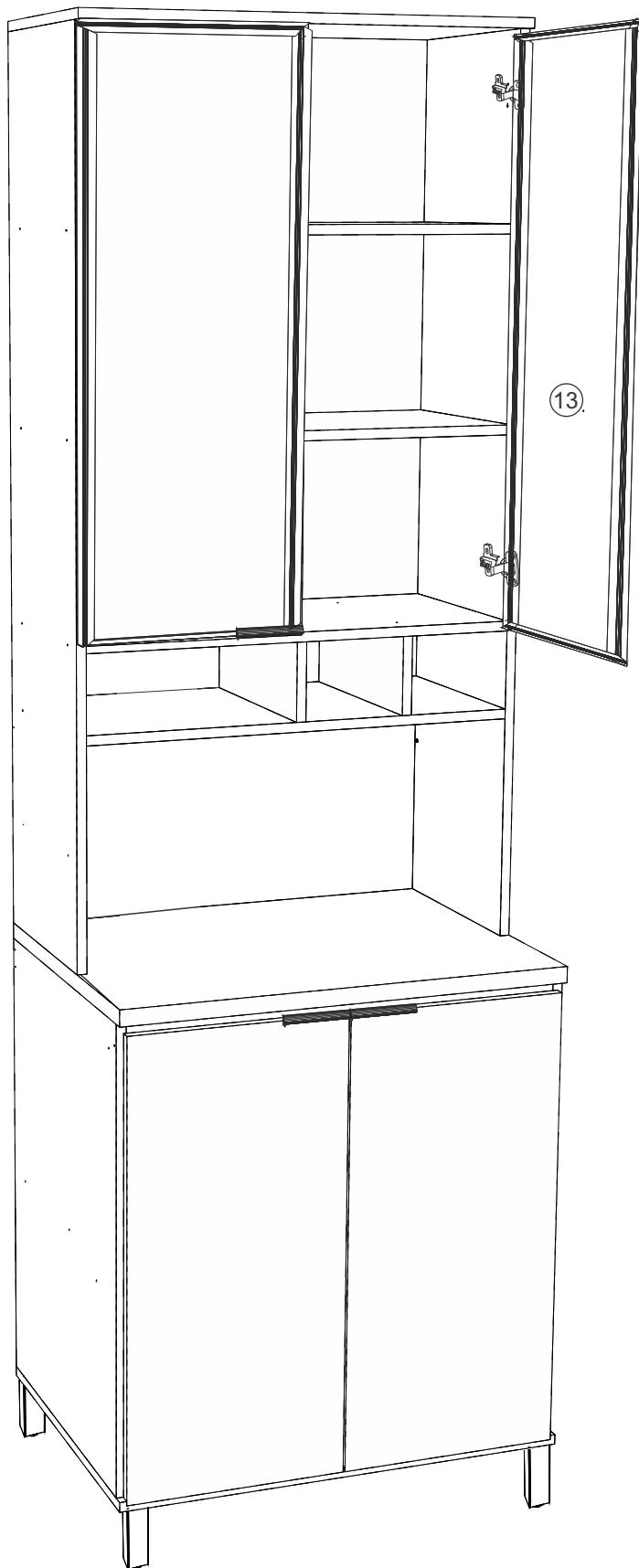

Limpeza/Limpieza

- ✍ Use um pano levemente umedecido com água, seguido de pano seco.
- ✍ *Use solamente un paño húmedo con agua y después un paño seco.*
- ✍ Nunca utilize produtos químicos ou abrasivos.
- ✍ *No utilice productos químicos o abrasivos.*