

ESQUEMA DE MONTAGEM

PRODUTO
PANELEIRO PAOLA TORRE QUENTE

CÓDIGO
2003708

MARTELO

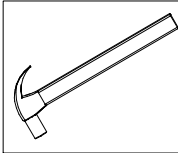

CHAVE PHILIPS

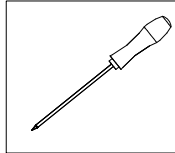

PARAFUSADEIRA

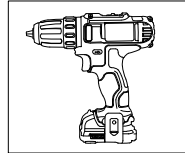

GARANTIA
90
DIAS

-EM CASO DE ASSISTÊNCIA INDICAR O CÓDIGO DO PRODUTO, CÓDIGO DA COR E O CÓDIGO DA PEÇA DANIFICADA

REFERÊNCIA 921 CARVALHO / BRANCO BRILHO	REFERÊNCIA 923 CARVALHO /GRAFITE	MEDIDAS E DESCRIÇÃO	QTDE.
370324/920	370324/920	COLUNA - 0310 X 095 X 15	1
370821/920	370821/920	LAT DIR PAN - 1970 X 450 X 15	1
370825/920	370825/920	CHAPEU C/ COLUNA - 0670 X 450 X 15	1
370827/920	370827/920	PRAT C/ COLUNA - 0670 X 450 X 15	1
370822/920	370822/920	LAT ESQ PAN - 1970 X 450 X 15	1
370023/920	370023/920	PRAT PAN - 0670 X 450 X 15	2
370024/920	370024/920	BASE C/ PÉ PAN - 0700 X 450 X 15	1
370823/526	370823-925	PORTA BASCULANTE - 0630 X 303 X 15	1
370824/526	370824-925	PORTA INF - 0614 X 315 X 15	2
370026/920	370026/920	VISTA ENGROSSO MENOR - 0637 X 033 X 15	5
370025/920	370025/920	VISTA ENGROSSO MAIOR - 2003 X 033 X 15	2
370001/920	370001/920	FUNDO PAN - 1970 X 344 X 03	2

ASPECTO FINAL

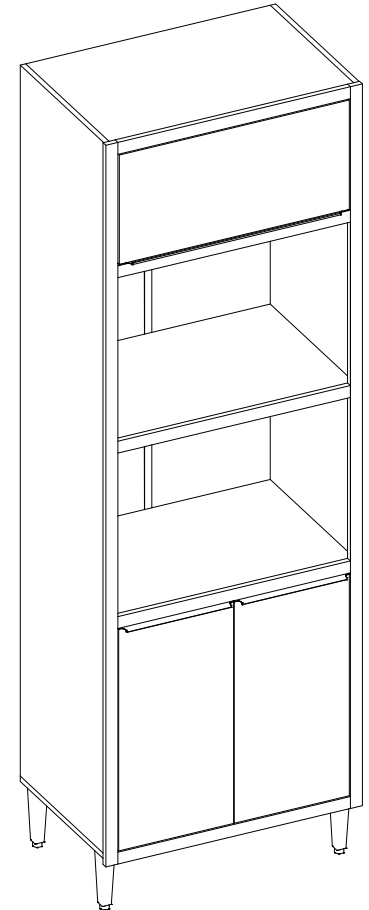















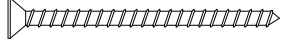

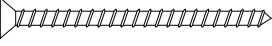
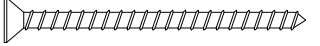



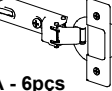

CORES	DIMENSÕES DO PRODUTO
CÓD. DESCRIÇÃO 921 - CARVALHO / BRANCO 923 - CARVALHO/GRAFITE	LARGURA:2150mm ALTURA:700mm PROFUNDIDADE:468mm

aramoveis

Depósito Guarulhos-SP
Rua: Junqueiro, N° 298 CEP: 07210-130
Jardim Araçongas (Estrada velha de São Miguel)
Fone: (11) 4803-4691
Fone: (11) 4803-4697
Whats: (43) 99914-0493
aramoveis@aramoveis.com.br

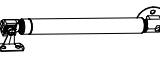
Fone:(43) 3274-8600 Fax (43) 3274-8601
Fone:(Assistência Técnica) 0800 707 2455
Rua: Gaturamo Bandeira 145 - Pq Industrial 2
CEP: 86703-290 Araçongas - Paraná
E-Mail: aramoveis@aramoveis.com.br
www.aramoveis.com.br

OS PARAFUSOS ESTÃO ESCALA DE TAMANHO REAL PARA MELHOR IDENTIFICAÇÃO

 A - 32006 PARAFUSO 3.5X12MM - 23pçs	 Y - 46247 PERFIL H 1940MM - 1pçs	 C - 32009 PARAFUSO 4.0X12MM FLAG. - 52pçs	 D - 32016 PARAFUSO MAQ4X25MM - 4pç
 E - 32011 PARAFUSO 4.0X40MM - 8pç	 F - 32005 PARAFUSO 4.0X45MM - 22pç	 G - 32051 PARAFUSO 5.0X40MM - 4pç	 H - 32013 PARAFUSO 6.0X60MM - 2pçs
 I - 32004 PREGO 08X08MM - 100pç	 J - 45000 CAVILHA 6.0X30MM - 18pç	 K - 37012 BUCHA DE FIXAÇÃO - 2pçs	 L - 38035 CANTONEIRA COZ/ANGULAR S/GUIA - 2pçs
 M - 38008 CALÇO 12MM - 2pçs	 N - 38007 CALÇO 5MM - 4pçs	 O - 38006 DOBRADIÇA - 6pçs	 P - 38002 CANTONEIRA DE PAREDE - 2pçs
 Q - 32018 PORCA SEXTAVADA 4MM - 4pç	 R - 37002 PORCA CILINDRICA - 4pçs	 S - 37032 CANTONEIRA COZ/ANGULAR - 25pçs	 T - 37034 DISTANCIADOR DE CALÇ. 25MM - 4pçs
 U - 38012 AMORTECEDOR A GAS 80 NY - 1pçs	 V - 46024 PÉ PLAST. 59X152MM REGUL. - 4pçs	 W - 46028 PUXADOR TRILH. CHANF. 315MM - 2pçs	 X - 46333 PUXADOR TRILH. CHANF. 630MM - 1pçs

MONTAGEM PASSO A PASSO

- 1° - É ACONSELHÁVEL FERRAR O CHÃO PARA MONTAGEM;
- 2° - É ACONSELHÁVEL MONTAR O PRODUTO DEITADO ONDE A FRENTE DO MESMO FIQUE PARA BAIXO;
- 3° - MONTAR TODAS AS PARTES CONFORME O ESQUEMA DE MONTAGEM;
- 4° - AS PORTAS E RODATELO SÃO AS ÚLTIMAS A SER FIXADAS;
- 5° - É NECESSÁRIO 02 PESSOAS PARA MONTAGEM.

1° - PREPARAÇÃO DAS PEÇAS

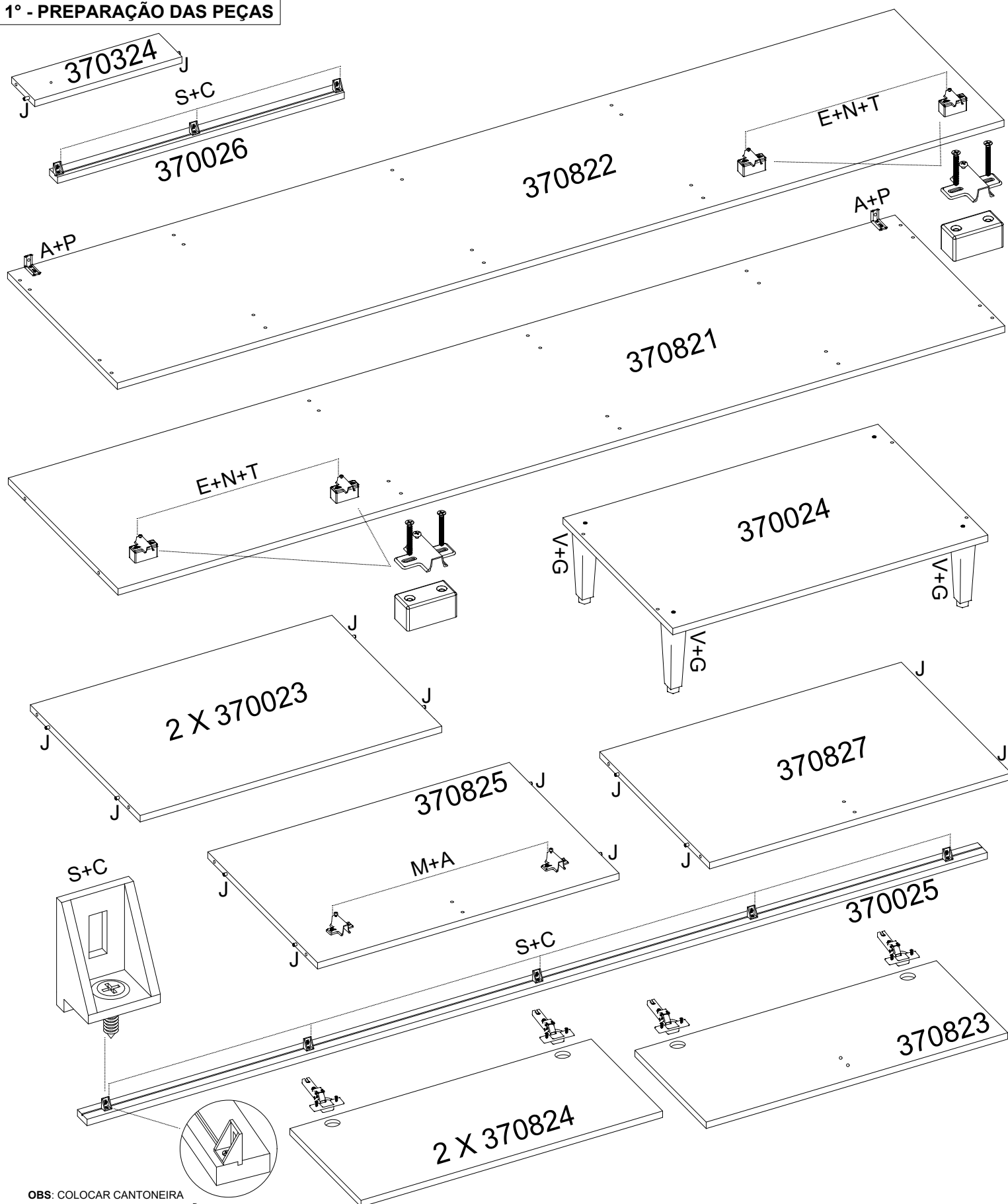

OBS: COLOCAR CANTONEIRA ANGULAR COM GUIA NESTA POSIÇÃO

2° - MONTAGEM ESTRUTURA PANELEIRO

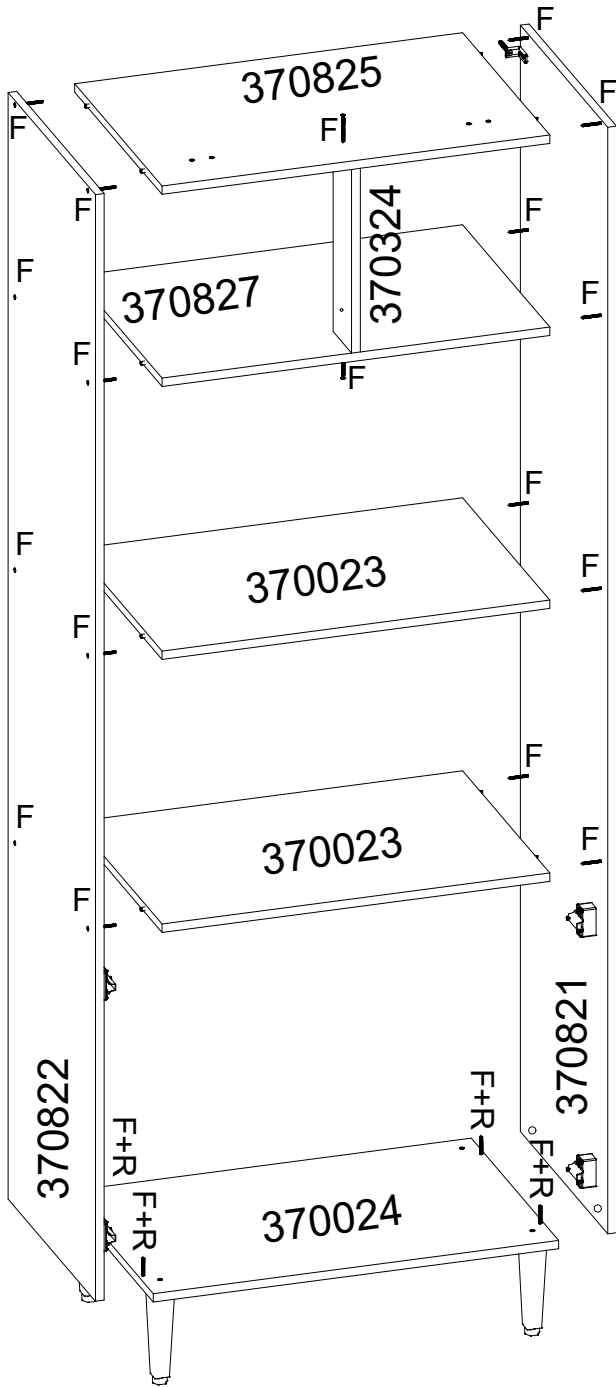

3° - FIXAÇÃO DOS FUNDOS

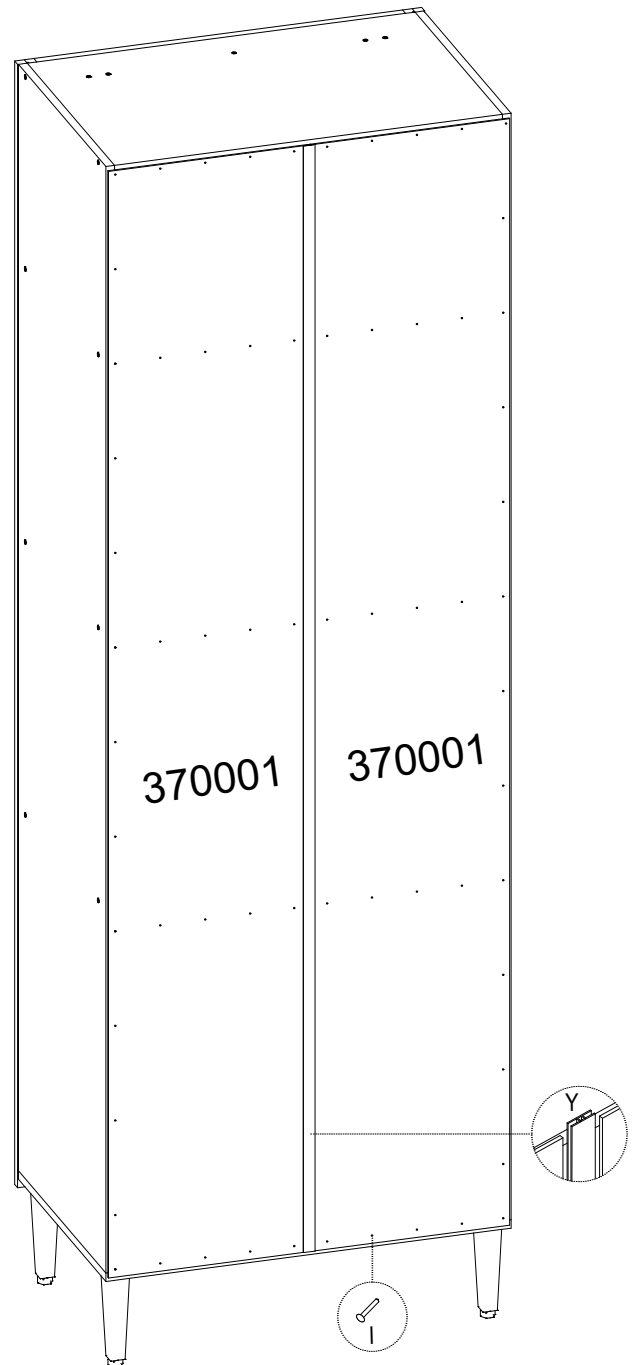

4° - COLOCAÇÃO DAS VISTAS ACABAMENTO

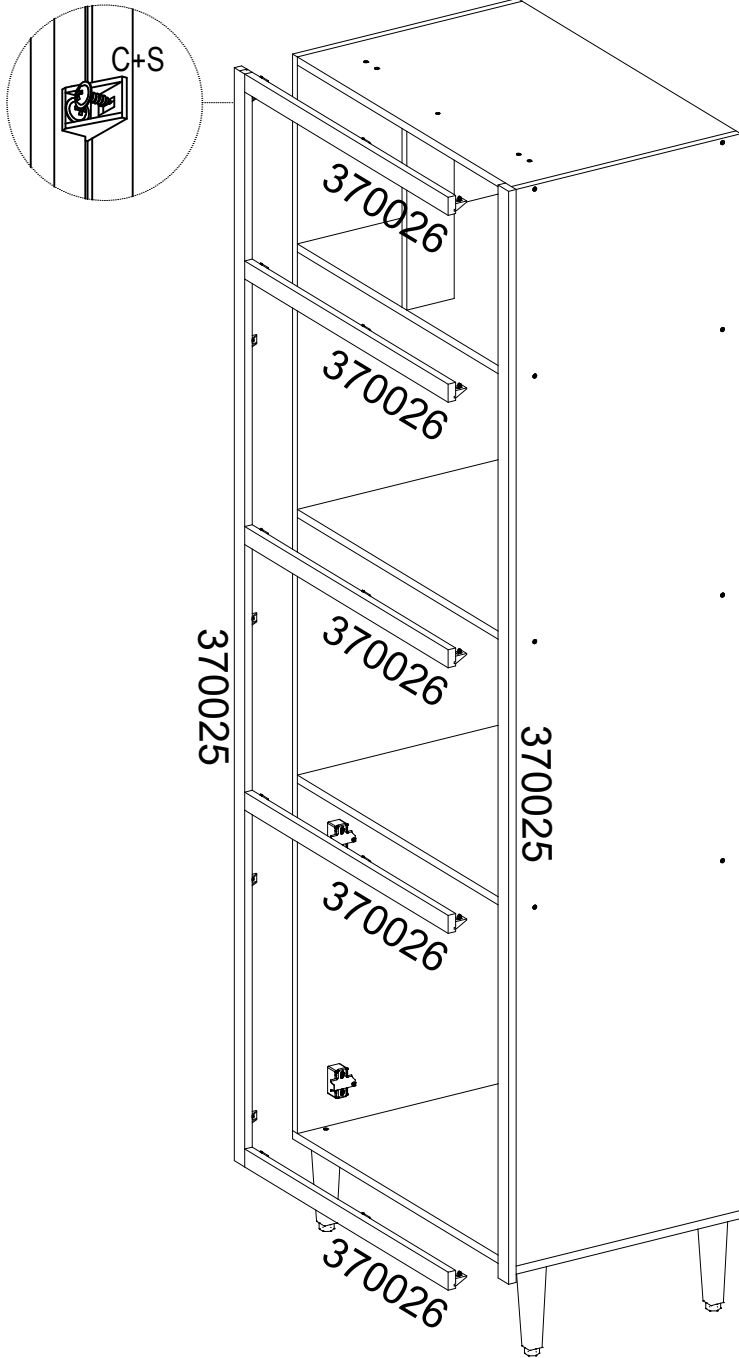

5° - COLOCAÇÃO DAS PORTAS

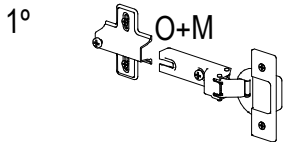
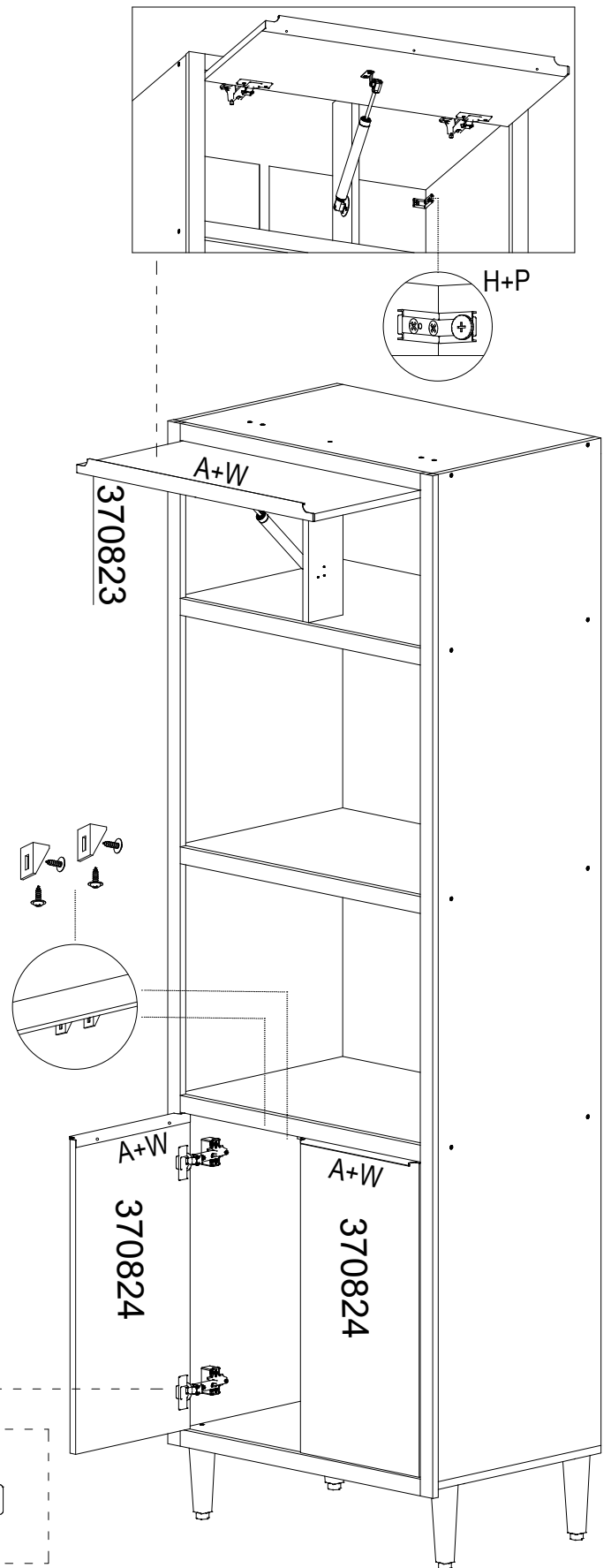

1°
FIXAR A DOBRADIÇA NA PORTA COMO MOSTRA O DESENHO AO LADO.

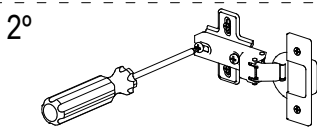

2°
FAZER A JUNÇÃO DA DOBRADIÇA COM O CALÇO E APERTAR O PARAFUSO CENTRAL.

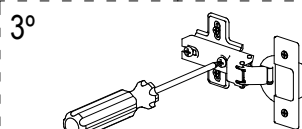

3°
APÓS A JUNÇÃO FECHAR A PORTA E FAZER A REGULAGEM PRECISA.