









# MESA CENTRO PRADA

BC-5030

## Ferragens/Herraje/Hardware:

330	A	Cavilhas 6 x 30 Clavija Bowel		12
0286	B	Parafuso 3,5 x 22 c/c Tornillo Screw		08
0290	C	Parafuso 3,5 x 14 c/c Tornillo Screw		32
0115	D	Parafuso minifix Tornillo Screw		08
0350	E	Tambor Girofix		08
3262	F	Conector Cotovelo M12 4 Pinos		08
0308	G	Sapata L 15 mm		08
0296	I	Taxa 10 x 7 Clavo 10 x 7 Nail 10 x 7		08
0477	J	Cola Pegamento Glue		01



medidas em mm

Dimensões Peças Prontas  
Dimensiones de Las Piezas Prontas  
Dimensions Ready Part

POR.	ESP.	ENG.	
01-Tampo superior	01-Tapa superior	01-Upper Top	01-905 X 596 X 15
02-Laterais (2x)	02-Lateral (2x)	02-Side (2x)	02-592 X 337 X 15
03-Travessa Esquerda (2x)	03-Travessaño Izquierdo (2x)	03-Left Crossbar (2x)	03-337 X 95 X 15
04-Travessa Direita (2x)	04-Travessaño Derecho (2x)	04-Right Crossbar (2x)	04-337 X 95 X 15
05-Travessas Maiores	05-Travessaños Maiores (2x)	05-Bigger Crossbar (2x)	05-871 X 95 X 15

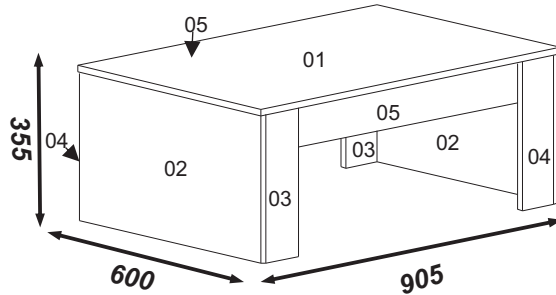

### 1º Passo

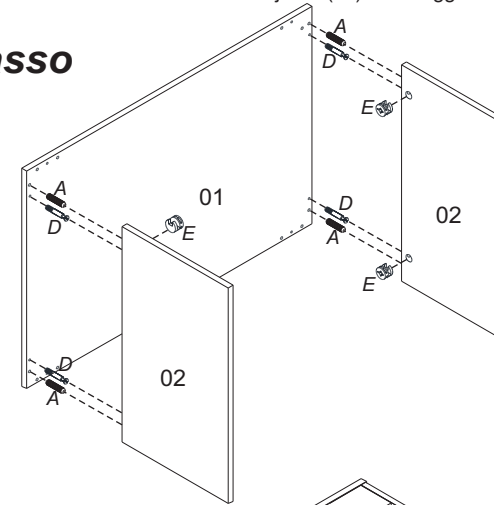

Lote: 00000

1) martelo  
martillo  
hammer



2) chave  
destornillador  
screwdriver

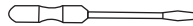

### 2º Passo

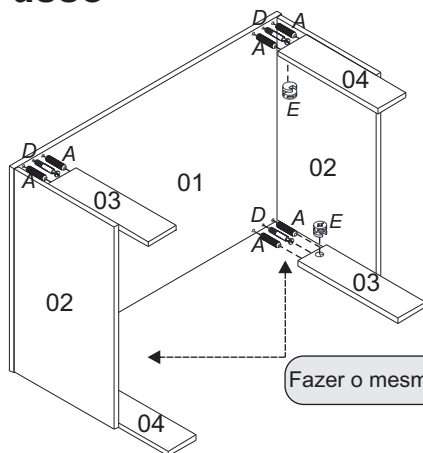

Fazer o mesmo na peça 04

### 3º Passo

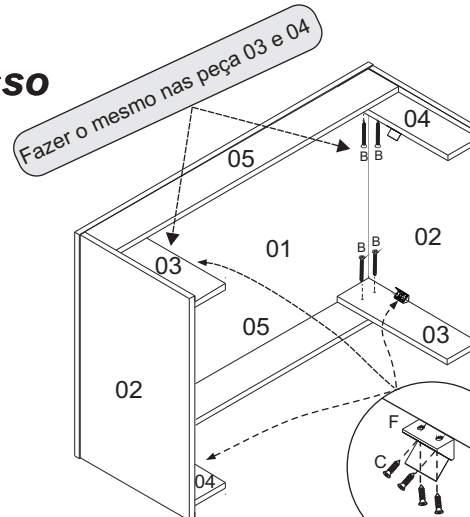

Fazer o mesmo nas peças 03 e 04

### 4º Passo

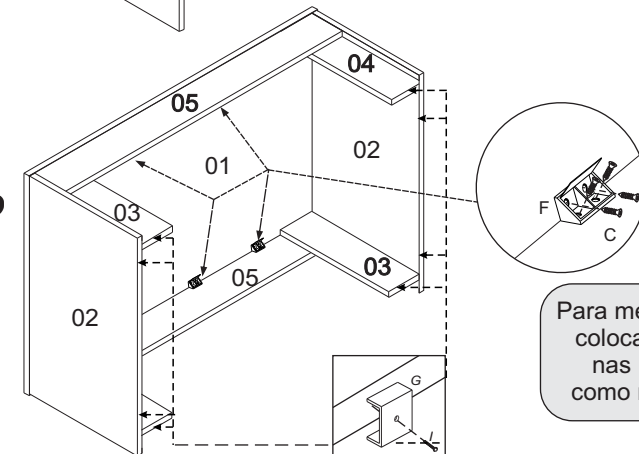

Para melhor fixação  
colocar conector  
nas peças 05  
como na imagem

Fazer nas peças  
nº02 03 04

Para melhor fixação  
colocar conector  
nas peças 03 e 04  
como na imagem

**MANUAL DE MONTAGEM**  
**INSTRUCCIONES DE ARMADO**  
**ASSEMBLY INSTRUCTIONS**